

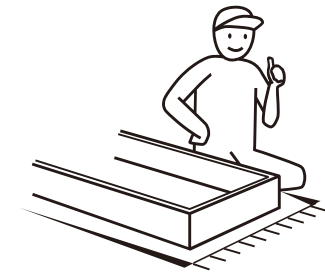

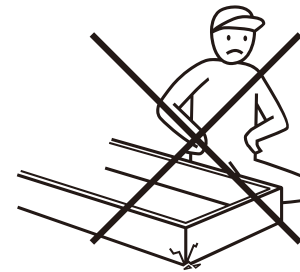

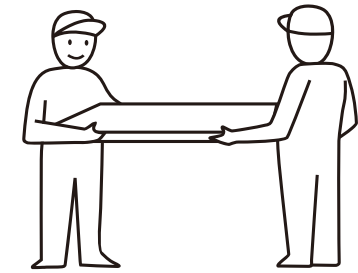

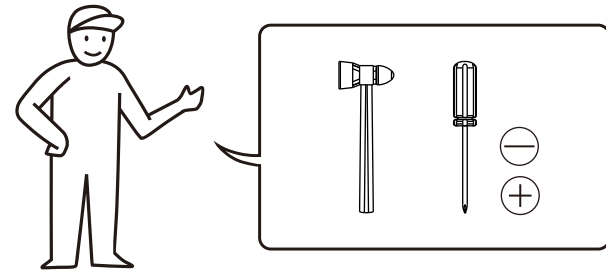



BY OGGI FURNITURE

ASSEMBLING INSTRUCTION

AXEL COMPUTER TRAY 45

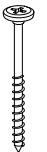

				
M3	CX3	CX2	J1	B1
∅ 6 MM X 13 MM 12 X	2 X	2 X	∅ 10 MM X 44 MM 8 X	∅ 6 X 30 MM 5 X

				
M3	CX3	CX2	J1	B1
∅ 6 MM X 13 MM 12 X	2 X	2 X	∅ 10 MM X 44 MM 8 X	∅ 6 X 30 MM 5 X

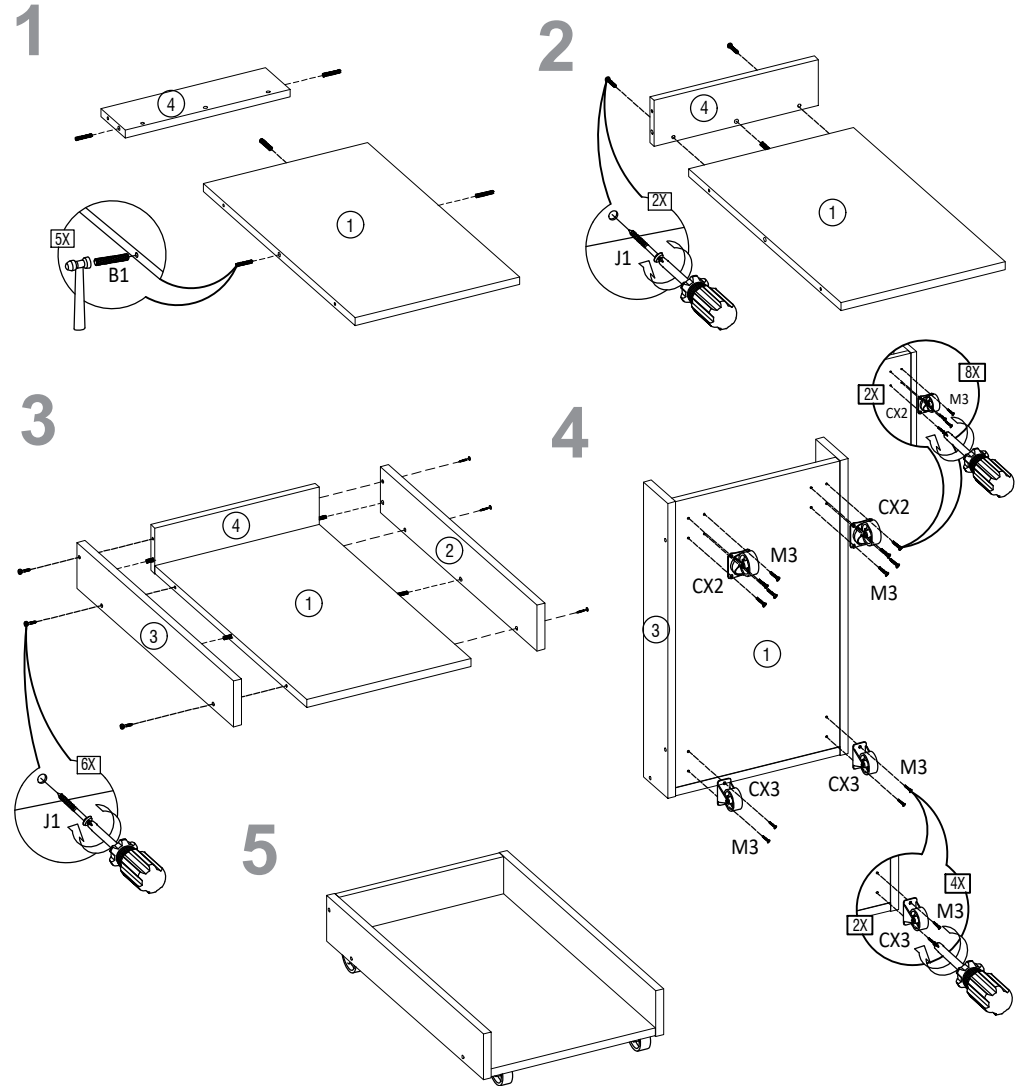
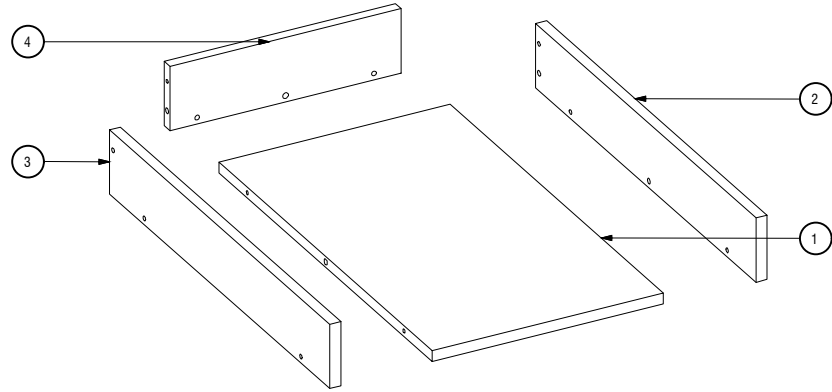

 x2 ±45 M 